

SIGN	DATE	DESCRIPTION	APPROVER
△	11/10'10	Current is changed from 75A to 65A	Aaron
△	11/10'10	Wire range is changed from 10-7 AWG to 10-6 AWG	Aaron
△	11/10'10	Add is cULus Mark	Aaron
△	12/12'12	Change the screw plating specification	Jacky
△	12/12'12	Change the dimensional tolerance	Jacky

THIS IS CAD DRAWING, DO NOT REVISE MANUALLY!!!

MATERIALS ELECTRICAL
RATED VOLTAGE & CURRENT: 600 V, 65A △
WITHSTAND VOLTAGE: AC 3000 V/Min
INSULATION RESISTANCE: 1000 MΩ OR MORE AT DC 500 V
OPERATING TEMPERATURE RANG: -40 °C ~ +115 °C
SCREW TORQUE VALUE: 26 Lb-In.
WIRE RANGE: 10 - 6 AWG △

1) BODY: THERMOPLASTICS, UL94-V0 BLACK
 2) TERMINAL: BRASS, 1.6t, Tin PLATED
 △ 3) TERMINAL SCREWS WITH WASHER: STEEL, M6.0
 4) COVER: PC, TRANSPARENT
 5) TERMINAL NUT: STEEL Ni PLATED M6.0

APPROVAL:  △

Critical dimension: ▽

PART NO.:

YK 902 xx 2 x x 00G

NO. OF POLES
 02: 2 POLES
 03: 3 POLES
 04: 4 POLES
 ...
 10: 10 POLES

RoHS compliant
 (lead<4%) In copper Alloy

MARK
 0: "@" MARK
 1: "ANY" MARK

TERMINAL & SCREW PLATED

0: TERMINAL & SCREW: G/F
 △ 1: TERMINAL: G/F, SCREW: Zinc
 2: TERMINAL: Sn, SCREW: G/F
 △ 3: TERMINAL: Sn, SCREW: Zinc

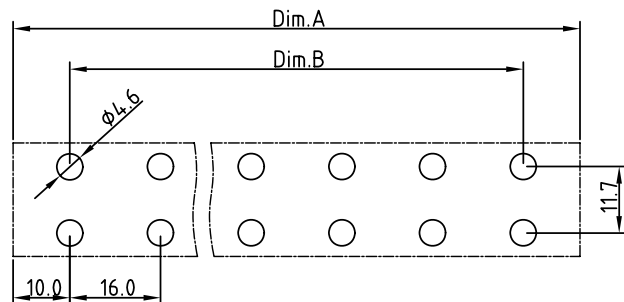
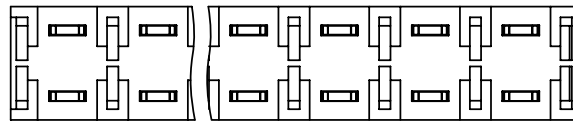
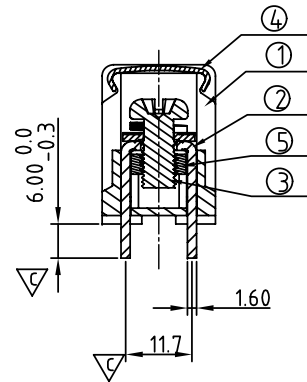
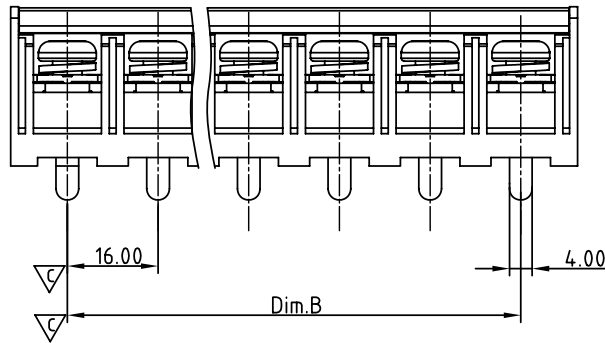
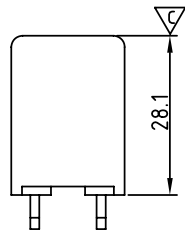
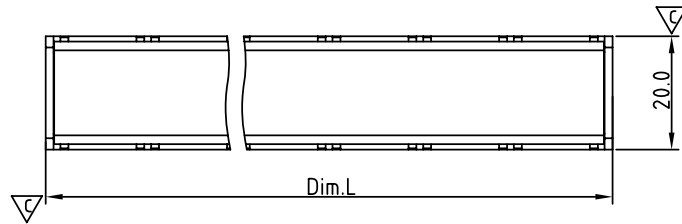

P.C.B LAYOUT(Top View)

N= Number of poles
 Dim.B= (N-1)x16.0
 Dim.L= (N-1)x16.0+20.0 △

POLE	2P~6P	7P~10P
Dim.B	±0.40	±0.50
Dim.L	±0.40	±0.50

ANYTEK

CUSTOMER COPY

ALL RIGHTS RESERVED. REPRODUCTION OR ISSUE TO THIRD PARTIES IN ANY FORM WHATEVER IS NOT PERMITTED WITHOUT WRITTEN AUTHORITY FROM THE PROPRIETOR. PROPERTY OF ANYTEK TECHNOLOGY CO., LTD

TITLE				YK902 With cover and W/o flange SERIES (成品脚长为6.00mmL)			
PART NO.		YK902xx2xx00G		DWG NO.		8YK0001-902	
APPROVED	CHECKED	DESIGNED	DRAWN	CUST NO.		Tolerance	
		Jacky 2012.12.12	Jacky 2012.12.12			UNIT: mm	
						SCALE: NONE	
SHEET: 01/01				REV.: E		X.X ±0.30	
						X.XX ±0.10	
						X° ±1°	